

Shyer fish are superior swimmers in Siberian sturgeon (*Acipenser baerii*)

Lingli Xiang¹, Xiangyuan Mi¹, Weiwei Li¹, Yingchao Dang², Chaoshuo Zhang¹, Yu Zeng³, Wei Jiang², Hao Du⁴, William Twardek⁵, Steven Cooke⁵, Jianghui Bao¹, and Ming Duan¹

¹Institute of Hydrobiology Chinese Academy of Sciences

²Chinese Sturgeon Research Institute, China Three Gorges Corporation

³China West Normal University

⁴Ministry of Agriculture/Yangtze River Fisheries Research Institute, Chinese Academy of Fisheries Science

⁵Carleton University

July 13, 2022

Abstract

Differences in individual personality are common amongst animals, which can play an ecological and evolutionary role given links to fitness. Personality affects animal life processes and outputs (e.g., behavior, life history, growth, survival, reproduction), and has become a common theme in animal behavioral ecology research. In the present study, we used Siberian Sturgeon to explore how personality traits of boldness and shyness are related to swimming performance, post exercise recovery and phenotypic morphology. Firstly, our results indicated that the Siberian sturgeon juveniles of shyness were better swimmers, validating evolutionary biology trade-off theory. The critical swimming speed (U_{crit}) of the shy groups was higher than that of the bold groups. Secondly, the shy groups were more resilient after exercise fatigue. The swimming fatigue recovery ability, the glucose and lactic acid concentration recovery ability of shy groups were greater than that of bold groups. Thirdly, the shy groups were more streamlined. Compared with bold groups, shy groups had smaller caudate stalk lengths, caudate stalk heights, superior caudal lobes, and inferior caudal lobes. These research results further enrich the theoretical viewpoints of fish behavior biology, more importantly, which provided a good example for studying the relationship between sturgeon's "personality" and swimming performance.

Hosted file

20220704_full_article.docx available at <https://authorea.com/users/494987/articles/576864-shyer-fish-are-superior-swimmers-in-siberian-sturgeon-acipenser-baerii>

Hosted file

20220407-figures.docx available at <https://authorea.com/users/494987/articles/576864-shyer-fish-are-superior-swimmers-in-siberian-sturgeon-acipenser-baerii>

Hosted file

20220407-tables.docx available at <https://authorea.com/users/494987/articles/576864-shyer-fish-are-superior-swimmers-in-siberian-sturgeon-acipenser-baerii>

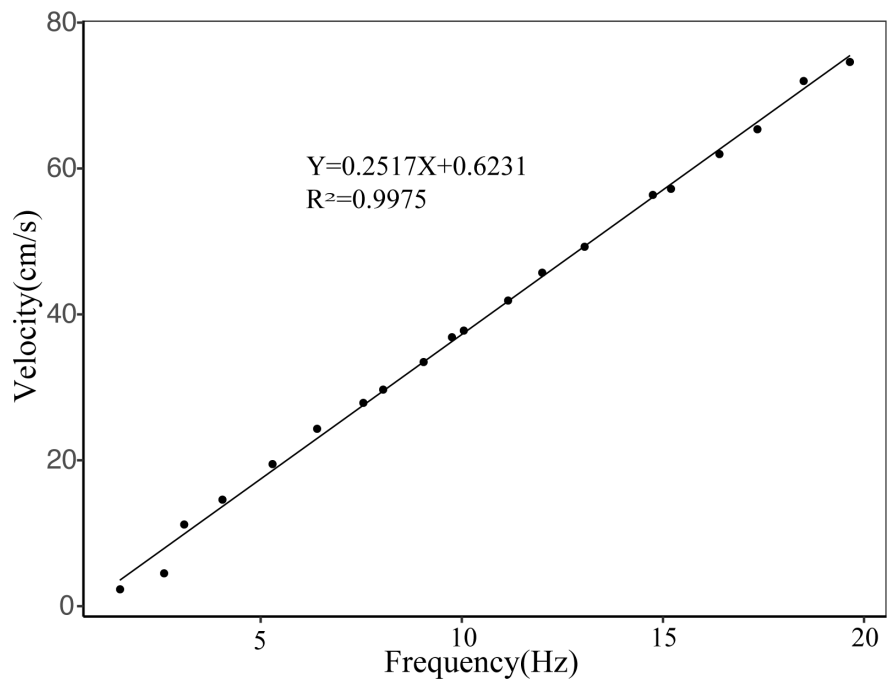
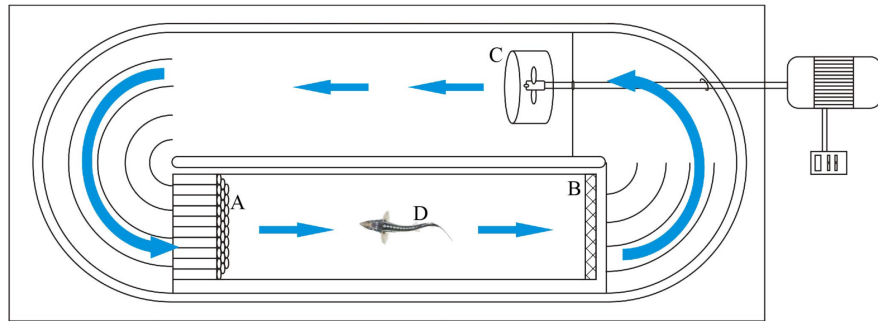
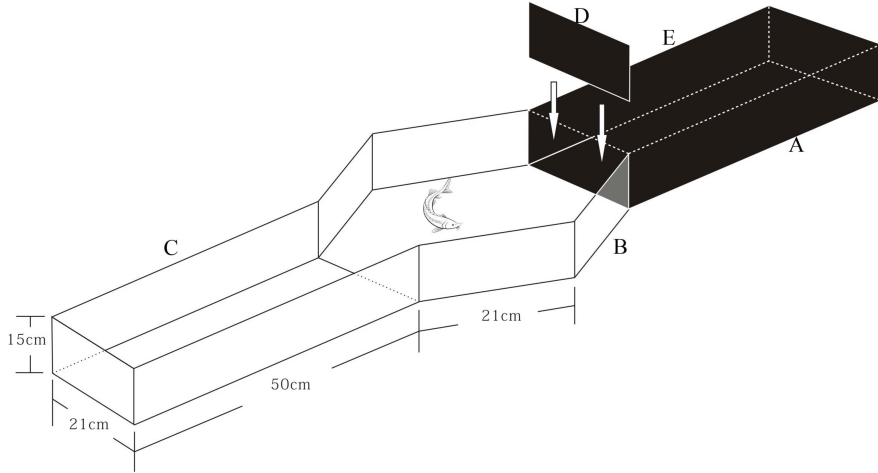

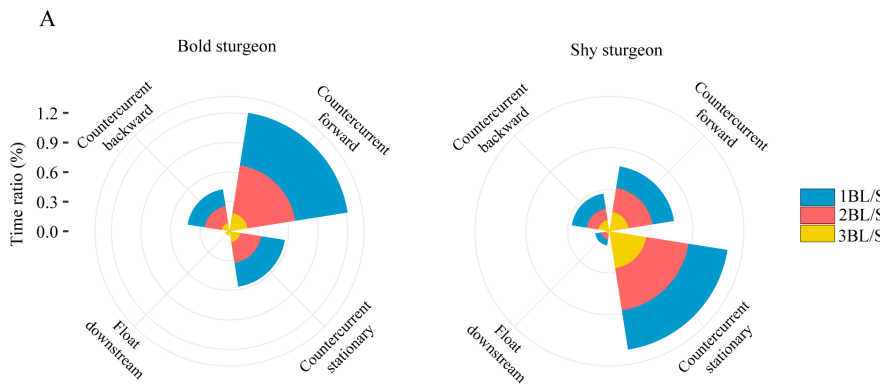
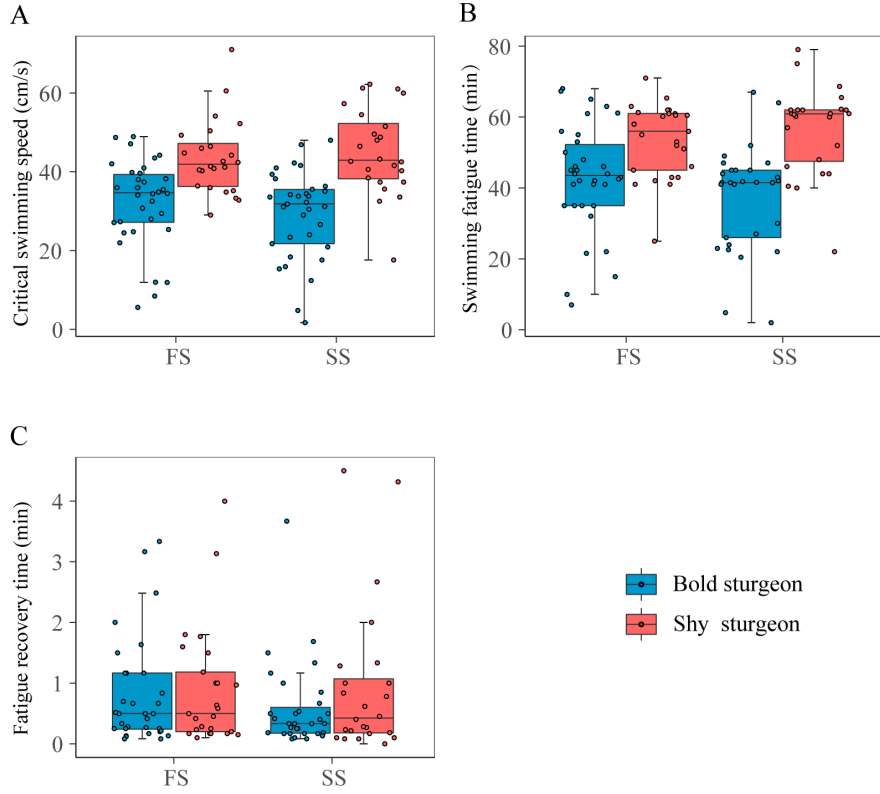
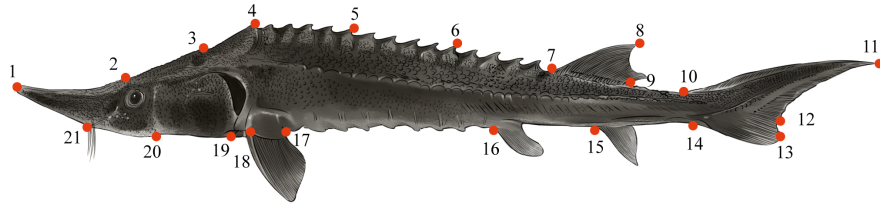

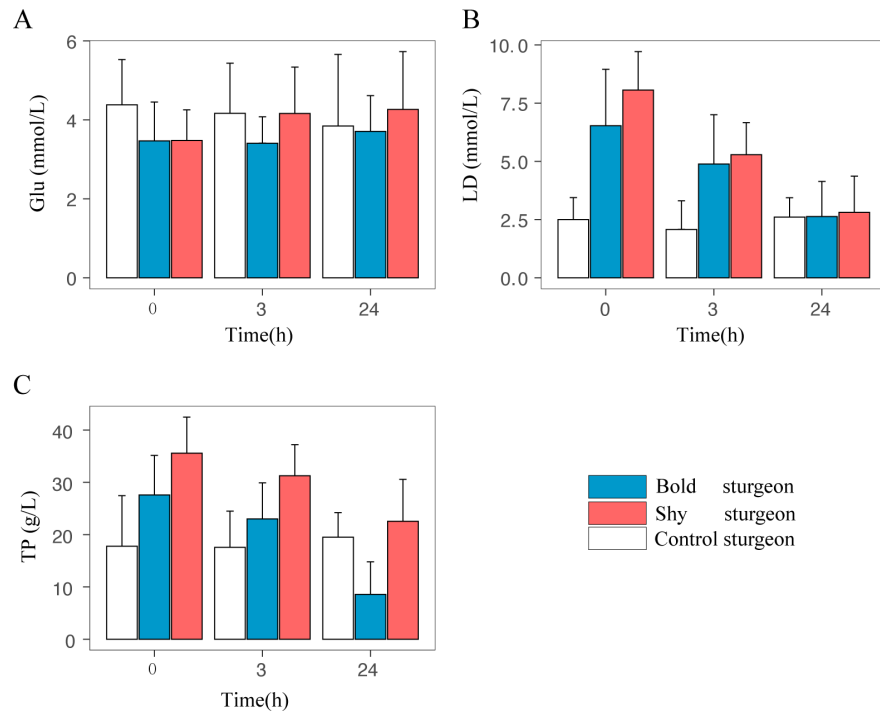
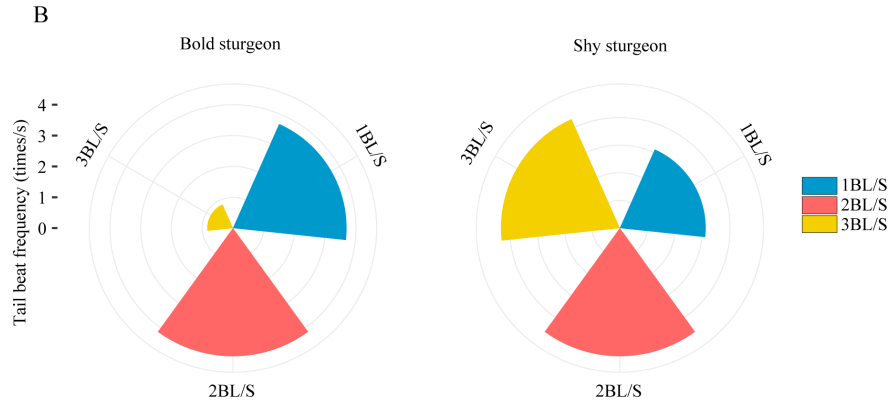

(a)

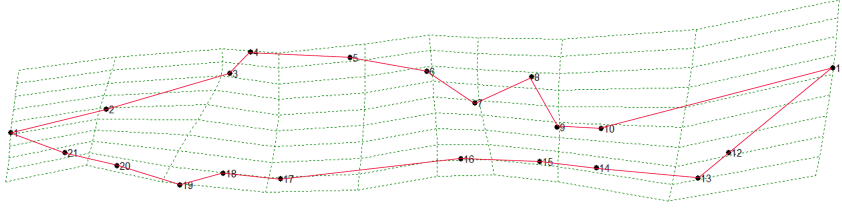

(b)

